

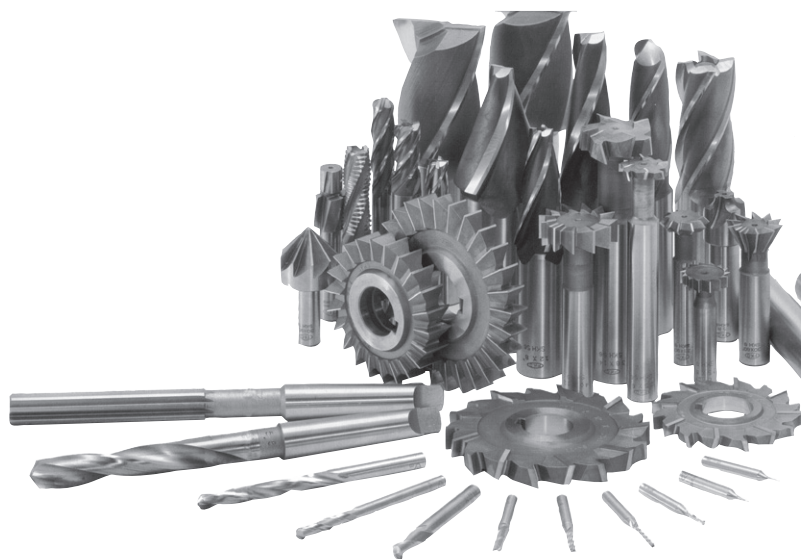



















エンドミル外径別索引	一般	6 ~ 35
	R形状	36 ~ 45
	テーパー	46 ~ 50

製品紹介	エンドミル End Mills	51 ~ 120
	柄付カッター Shank Type Cutters	121 ~ 162
	沈めフライス Countersinks & Counterbores	163 ~ 169
	横型フライスカッター Milling Cutters	170 ~ 186
	リーマ Reamers	187 ~ 188
	3S ドリル (ハイス) Countersinks with Drills	189
	超硬付刃ドリル Tungsten Carbide Tipped Drills	190 ~ 197
	トリミングダイス Trimming Dies	198



















INDEX

SINCE 1935
F.K.D.®

型番		材質	品名	ページ
エンドミル		End Mills		
2SF		SKH56	3Sエンドミル2枚刃 (標準刃) 2-Flute Standard End Mills	51-57
2LF 2XLF		SKH56	3Sエンドミル2枚刃ロング刃 3Sエンドミル2枚刃特ロング刃 2-Flute Long Flute & Extra Long Flute End Mills	58-64
LS-2LF		SKH56	ロングシャクエンドミル2枚刃 2-Flute Long Shank End Mills	65
XLS-2SF		SKH56	特ロングシャクエンドミル2枚刃 2-Flute Extra Long Shank End Mills	66-67
4SF		SKH56	3Sエンドミル4枚刃 (標準刃) 4-Flute Standard End Mills	68-72
6SF		SKH56	3Sエンドミル6枚刃 6-Flute Standard End Mills	73
4LF 4XLF		SKH56	3Sエンドミル4枚刃ロング刃 3Sエンドミル4枚刃特ロング刃 4-Flute Long Flute & Extra Long Flute End Mills	74-79
6XLF		SKH56	3Sエンドミル6枚刃特ロング刃 6-Flute Extra Long Flute End Mills	80
LS-4LF		SKH56	ロングシャクエンドミル4枚刃 4-Flute Long Shank End Mills	81
XLS-4SF		SKH56	特ロングシャクエンドミル4枚刃 4-Flute Extra Long Shank End Mills	82-83
3SG-2		SKH56	3SGエンドミル2枚刃 2-Flute 3SG Giant End Mills (Hi-Helical, Ultra F, Stainless Use)	84
3SG-4		SKH56	3SGエンドミル4枚刃 4-Flute 3SG Giant End Mills (Hi-Helical, Ultra F, Stainless Use)	84
2BE		SKH56 & SKH57	ボールエンドミル2枚刃 2-Flute Ball End Mills	85-88
4BE		SKH56 & SKH57	ボールエンドミル4枚刃 4-Flute Ball End Mills	89
2LS-BE		SKH57	ロングシャクボールエンドミル2枚刃 2-Flute Long Shank Ball End Mills	90
4LS-BE		SKH57	ロングシャクボールエンドミル4枚刃 4-Flute Long Shank Ball End Mills	91
XLS-BE		SKH56	特ロングシャクボールエンドミル2枚刃 2-Flute Extra Long Shank Ball End Mills	92
LF-BE		SKH57	ロング刃ボールエンドミル2枚刃 2-Flute Long Flute Ball End Mills	92
NBE		粉末ハイス	テーバーネックボールエンドミル Tapered Neck Ball End Mills	93



















I N D E X

SINCE 1935
F.K.D.®

型番		材質	品名	ページ
エンドミル		End Mills		
2RBE		SKH56	ラジラスエンドミル2枚刃 2-Flute Radius Ball End Mills	94-96
4RBE		SKH56	ラジラスエンドミル4枚刃 4-Flute Radius Ball End Mills	97-98
CRE		SKH51	コーナーラウンディングエンドミル4枚刃 Corner Rounding End Mills	99
CM		SKH56	センター面取りミル2枚刃 Center Chamfering End Mills	100
CMU		SKH56	センター面取りミル(UF処理) 浸透拡散処理 Center Chamfering End Mills (Ultra F. Heat Treatment)penetrated / spreaded heat-treatment	101
2TE		SKH56	テーパ刃エンドミル2枚刃 2-Flute Tapered End Mills	102-103
2TE-S		SKH56	テーパ刃エンドミル2枚刃 (ショート刃) 2-Flute Tapered End Mills (Short Flute)	104
4TE		SKH56	テーパ刃エンドミル4枚刃 4-Flute Tapered End Mills	105-106
4TE-S		SKH56	テーパ刃エンドミル4枚刃 (ショート刃) 4-Flute Tapered End Mills (Short Flute)	107
RB2TE		SKH56	テーパラジラスエンドミル2枚刃 2-Flute Tapered Radius Ball End Mills	108-109
SE		SKH51	シェルエンドミル Shell End Mills	110
KE-OH		SKH56	キー溝用エンドミル(プラス公差)ストレートシャンク Key Way End Mills, Straight Shank (Over High Tolerance)	111
KE-OH-BS5		SKH55	キー溝用エンドミル(プラス公差)テーパシャンク Key Way End Mills, BS5 Shank (Over High Tolerance)	111
KE-OL		SKH56	キー溝用エンドミル(マイナス公差)ストレートシャンク Key Way End Mills, Straight Shank (Over Low Tolerance)	112
KE-OL-BS5		SKH55	キー溝用エンドミル(マイナス公差)テーパシャンク Key Way End Mills, BS5 Shank (Over Low Tolerance)	112
2S-T		SKH56	引きネジ付3Sエンドミル2枚刃(テーパシャンク) 2-Flute End Mills, Drawing Thread Taper Shank	113
4S-T		SKH56	引きネジ付3Sエンドミル4枚刃(テーパシャンク) 4-Flute End Mills, Drawing Thread Taper Shank	114
2SL-T		SKH56	引きネジ付ロングハイヘリエンドミル2枚刃(テーパシャンク) 2-Flute Hi-Helical Long Flute End Mills, Drawing Thread Taper Shank	115
4SL-T		SKH56	引きネジ付ロングハイヘリエンドミル4枚刃(テーパシャンク) 4-Flute Hi-Helical Long Flute End Mills, Drawing Thread Taper Shank	115



















INDEX

SINCE 1935
F.K.D.®

型番		材質	品名	ページ
エンドミル		End Mills		
RE		SKH56	ラフニングエンドミル Roughing End Mills	116
SL-BS		SKH51	スロッチングエンドミル2枚刃テーパシャंक 2-Flute Slotting End Mills, BS Shank	117
SL-MT		SKH51	スロッチングエンドミル2枚刃テーパシャंक 2-Flute Slotting End Mills, Morse Taper Shank	117
SL-BS-L		SKH51	ロングスロッチングエンドミル2枚刃テーパシャंक 2-Flute Long Flute Slotting End Mills, BS Shank	118
SP-MT		SKH51	スパイラルエンドミル (テーパシャंक) Left Hand Spiral End Mills, Morse Taper Shank	119
SP-BS		SKH51	スパイラルエンドミル (テーパシャंक) Left Hand Spiral End Mills, BS Shank	119
SP-BS-L		SKH51	ロングスパイラルエンドミル (テーパシャंक) Left Hand, Long Flute Spiral End Mills, BS Shank	120
柄付カッター		Shank Type Cutters		
KC		SKH51	キーシートカッター Woodruff Keyseat Cutters	121-130
KCST		SKH51	側刃付 キーシートカッター Woodruff Keyseat Cutters, with Side Tooth	131-132
TC		SKH51	Tスロットカッター T-Slot Cutters, Straight Tooth	133-141
LS-TC		SKH56	ロングシャंकTスロットカッター T-Slot Cutters, Straight Tooth, Long Shank	142-143
STC		SKH56	千鳥刃Tスロットカッター T-Slot Cutters, Staggered Tooth	144-152
LS-STC		SKH56	ロングシャंक千鳥刃Tスロットカッター T-Slot Cutters, Staggered Tooth, Long Shank	153-156
TC/LS-TC STC/LS-STC			(TC / LS-TC)(STC / LS-STC) 両サイド刃の長さ Technical Information (Length of Side Tooth)	157
TSE		SKH56	Tスロットエンドミル T-Slot End Mills	158-159
SAC		SKH51	柄付アングルカッター Dovetail Cutters (Shank Type Ang Cutters)	160-161
SWC		SKH51	柄付Wアングルカッター Double Angle Cutters (Shank Type W Angle Cutters)	162
SPC		SKH51	柄付傘型カッター Face Angle Cutters (Shank Type Parasol Cutters)	162

I N D E X

SINCE 1935
F.K.D.®

型番		材質	品名	ページ
沈めフライス		Counterbores & Countersinks		
CC		SKH56	チャタレス面取りフライス Chatterless Countersinks	163
CB		SKH51	沈めフライス(六角穴付ボルト用) Cap Screw Counterbores	164
LS-CB		SKH56	ロングシャंक沈めフライス(JIS規格) Long Shank Cap Screw Counterbores (JIS Cap Screw)	165
CBT		SKH51	沈めフライス(六角穴付ボルト用)テーパシャंक Cap Screw Counterbores, Morse Taper Shank	166
EP-CB		SKH56	押し出しピン用沈めフライス Ejector Pin Counterbores	167
MS-CB		SKH51	皿小ネジ用沈めフライス Machine Screw Countersinks	167
DCB		SKH51	ドリル付沈めフライス(六角穴付ボルト用) Cap Screw Counterbores with Drill	168
DCS		SKH51	ドリル付皿小ネジ用沈めフライス Machine Screw Countersinks with Drill	168
DSS		SKH51	ドリル付皿小ネジ下穴用沈めフライス Machine Screw Countersinks with Drill, Pre-Tapping Sizes	168
3C		SKH56	3Cミル(六角穴付ボルトMC用面取付座繰りカッター) 3C Mills (Centering, Counterbore & Chamfering)	169
横型フライスカッター		Milling Cutters		
SC		SKH51	サイドカッター Side Milling Cutters, Straight Tooth	170-173
SSC		SKH55	千鳥刃サイドカッター Side Milling Cutters, Staggered Tooth	174-177
AC-RH		SKH51	シングルアングルカッター(右刃) Single Angle Cutters, Right Hand	178-180
AC-LH		SKH51	シングルアングルカッター(左刃) Single Angle Cutters, Left Hand	181-183
WAC		SKH51	ダブルアングルカッター Double Angle Cutters	184-186
リーマ		Reamers		
MR		SKH51	マシンリーマ Machine Reamers, Morse Taper Shank	187
CR		SKH51	センターリーマ Center Reamers	188
CR-MT		SKH51	センターリーマ (テーパシャंक) Center Reamers, Morse Taper Shank	188

INDEX

SINCE 1935
F.K.D.®

型番		材質	品名	ページ
3S ドリル (ハイス)		Countersinks with Drills		
SRM		SKH51	3S ドリル R型 (六角穴付きボルト用) Countersink with drill for cap Screws	189
SSM		SKH51	3S ドリル S型 (皿小ねじ用) Countersink with drill for machine screw	189
SHM		SKH51	3S ドリル H型 (平小ねじ用) Countersink with drill for flat head Screw	189
超硬付刃ドリル		Tungsten Carbide Tipped Drills		
SD		G2	超硬付刃ストレートシャンクドリル Straight Shank Drills, G-2 Tungsten Carbide Tipped	190-191
SSD		G2	超硬先ムクストレートシャンクドリル Straight Shank Drills, G-2 Top Solid Tungsten Carbide	192
TD		G2	超硬付刃テーパシャンクドリル Taper Shank Drills, G-2 Tungsten Carbide Tipped	193-195
STD		G2	超硬先ムクテーパシャンクドリル Taper Shank Drills, G-2 Top Solid Tungsten Carbide	196
SLD		G2	超硬付刃スリムシャンクドリル Collet Use Carbide Tipped Drills	197
トリミングダイス		Trimming Dies		
TRD		SKH55	トリミングダイス Trimming Dies	198